

4 PIN SOP PHOTOTRANSISTOR PHOTOCOUPLER

EL357 Series

Features:

- Current transfer ratio
(CTR: 50~600% at $I_F = 5\text{mA}$, $V_{CE} = 5\text{V}$)
- High isolation voltage between input
and output ($V_{iso} = 3750\text{ V rms}$)
- Compact small outline package
- Pb free and RoHS compliant.
- UL approved (No. E214129)
- VDE approved (No. 132249)
- SEMKO approved
- NEMKO approved
- DEMKO approved
- FIMKO approved
- CSA approved



Schematic

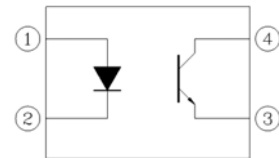

Pin Configuration

1. Anode
2. Cathode
3. Emitter
4. Collector

Description

The EL357 series contains an infrared emitting diode, optically coupled to a phototransistor. It is packaged in a 4-pin small outline SMD package.

Applications

- Programmable controllers
- System appliances, measuring instruments
- Telecommunication equipments
- Home appliances, such as fan heaters, etc.
- Signal transmission between circuits of different potentials and impedances



LIGHTING FOREVER

4 PIN SOP PHOTOTRANSISTOR PHOTOCOUPLER

EL357 Series

Absolute Maximum Ratings ($T_a=25^{\circ}\text{C}$)

Parameter		Symbol	Rating	Unit
Input	Forward current	I_F	50	mA
	Peak forward current (1us, pulse)	I_{FP}	1	A
	Reverse voltage	V_R	6	V
	Power dissipation Derating factor (above $T_a = 100^{\circ}\text{C}$)	P_D	70	mW
	2.9		mW/ $^{\circ}\text{C}$	
Output	Power dissipation Derating factor (above $T_a = 80^{\circ}\text{C}$)	P_C	150	mW
			3.7	mW/ $^{\circ}\text{C}$
	Collector current	I_C	80	mA
	Collector-Emitter voltage	V_{CEO}	80	V
	Emitter-Collector voltage	V_{ECO}	7	V
Total power dissipation		P_{TOT}	200	mW
Isolation voltage ^{*1}		V_{ISO}	3750	V rms
Operating temperature		T_{OPR}	-55 ~ +110	$^{\circ}\text{C}$
Storage temperature		T_{STG}	-55 ~ +125	$^{\circ}\text{C}$
Soldering temperature ^{*2}		T_{SOL}	260	$^{\circ}\text{C}$

Notes

*1 AC for 1 minute, R.H.= 40 ~ 60% R.H. In this test, pins 1 & 2 are shorted together, and pins 3 & 4 are shorted together.

*2 For 10 seconds.



LIGHTING FOREVER

4 PIN SOP PHOTOTRANSISTOR PHOTOCOUPLER

EL357 Series

Electrical Characteristics (T_a=25°C unless specified otherwise)

Input

Parameter	Symbol	Min.	Typ.*	Max.	Unit	Condition
Forward voltage	V _F	-	1.2	1.4	V	I _F = 20mA
Reverse current	I _R	-	-	10	μA	V _R = 4V
Input capacitance	C _{in}	-	30	250	pF	V = 0, f = 1kHz

Output

Parameter	Symbol	Min.	Typ.*	Max.	Unit	Condition
Collector-Emitter dark current	I _{CEO}	-	-	100	nA	V _{CE} = 20V, I _F = 0mA
Collector-Emitter breakdown voltage	BV _{CEO}	80	-	-	V	I _C = 0.1mA
Emitter-Collector breakdown voltage	BV _{ECO}	7	-	-	V	I _E = 0.1mA

Transfer Characteristics (T_a=25°C unless specified otherwise)

Parameter	Symbol	Min.	Typ.*	Max.	Unit	Condition
Current Transfer ratio	EL357	50	-	600	%	I _F = 5mA, V _{CE} = 5V
	EL357A	80	-	160		
	EL357B	130	-	260		
	EL357C	200	-	400		
	EL357D	300	-	600		
Collector-Emitter saturation voltage	V _{CE(sat)}	-	0.1	0.2	V	I _F = 20mA, I _C = 1mA
Isolation resistance	R _{IO}	5×10 ¹⁰	-	-	Ω	V _{IO} = 500Vdc, 40~60% R.H.
Floating capacitance	C _{IO}	-	0.6	1.0	pF	V _{IO} = 0, f = 1MHz
Cut-off frequency	f _c	-	80	-	kHz	V _{CE} = 5V, I _C = 2mA R _L = 100Ω, -3dB
Rise time	t _r	-	6	18	μs	V _{CE} = 2V, I _C = 2mA, R _L = 100Ω
Fall time	t _f	-	8	18	μs	

* Typical values at T_a = 25°C

4 PIN SOP PHOTOTRANSISTOR PHOTOCOUPLER

EL357 Series

Typical Performance Curves

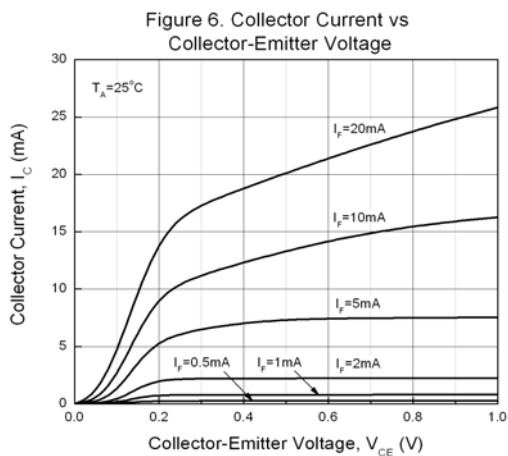
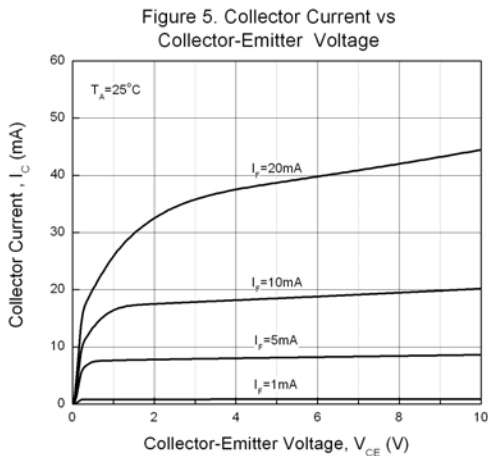
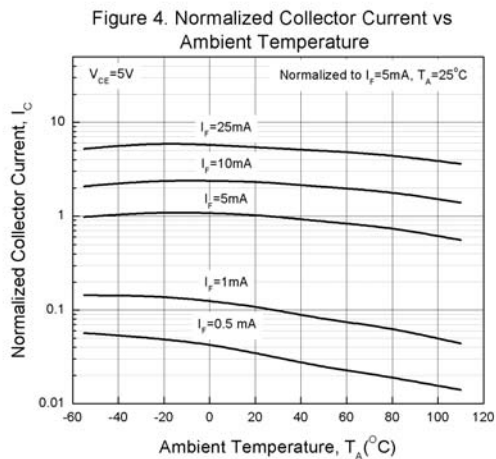
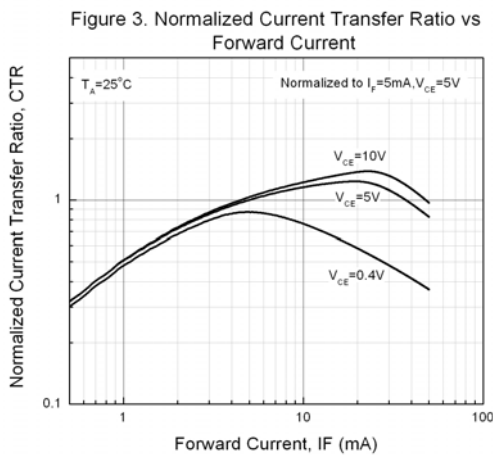
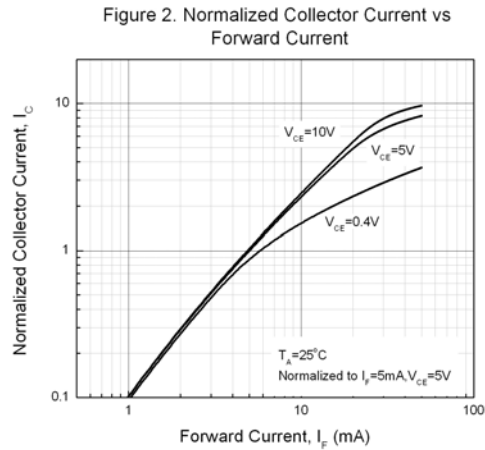
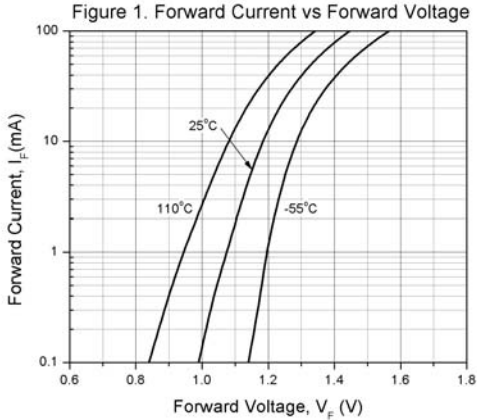

4 PIN SOP PHOTOTRANSISTOR PHOTOCOUPLER

EL357 Series

Figure 7. Collector Dark Current vs Ambient Temperature

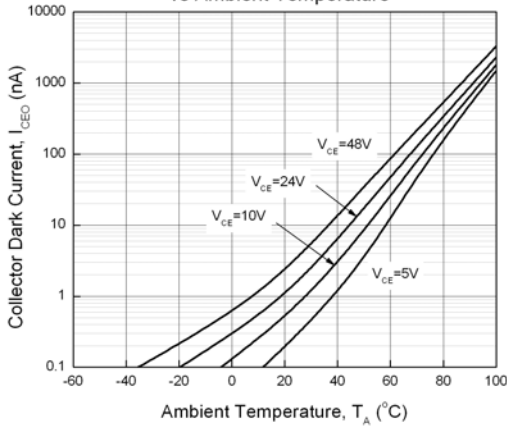

Figure 8. Switching Time vs Load Resistance

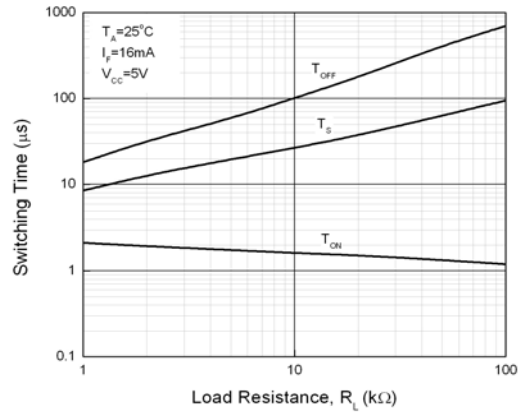

Figure 9. Collector-Emitter Saturation Voltage vs Ambient Temperature

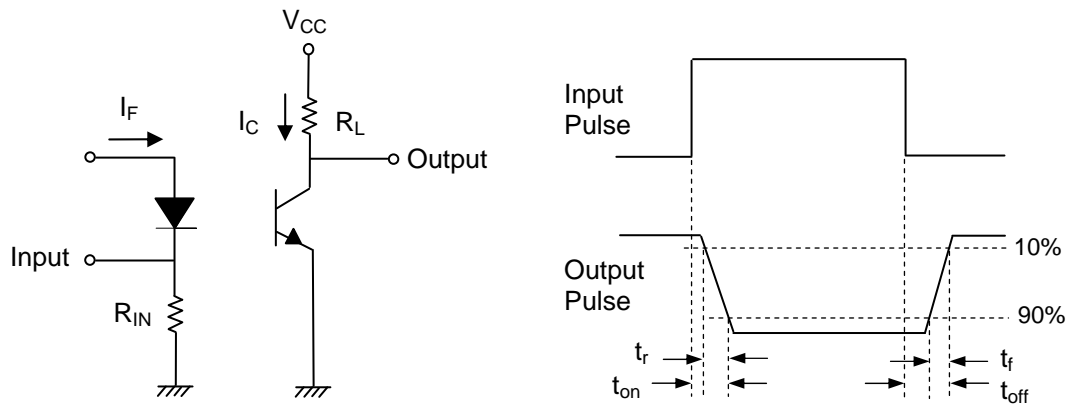
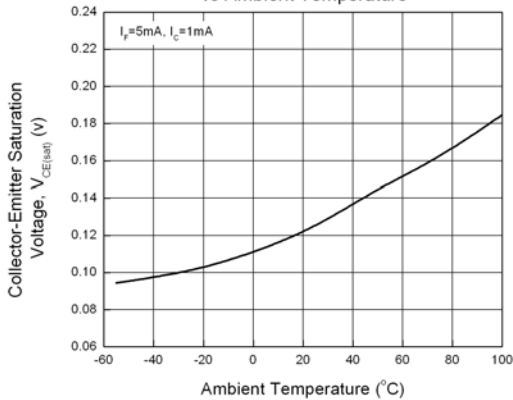

Figure 10. Switching Time Test Circuit & Waveforms



LIGHTING FOREVER

4 PIN SOP PHOTOTRANSISTOR PHOTOCOUPLER

EL357 Series

Order Information

Part Number

EL357(X)(Y)-V

Note

- X = CTR Rank (A, B, C, D or none)
- YY = Tape and reel option (TA, TB or none).
- V = VDE option

Option	Description	Packing quantity
None	Standard SMD option	100 units per tube
-V	Standard SMD option + VDE	100 units per tube
(TA)	TA Tape & reel option	3000 units per reel
(TB)	TB Tape & reel option	3000 units per reel
(TA)-V	TA Tape & reel option + VDE	3000 units per reel
(TB)-V	TB Tape & reel option + VDE	3000 units per reel

4 PIN SOP PHOTOTRANSISTOR PHOTOCOUPLER

EL357 Series

Package Drawing (Dimensions in mm)

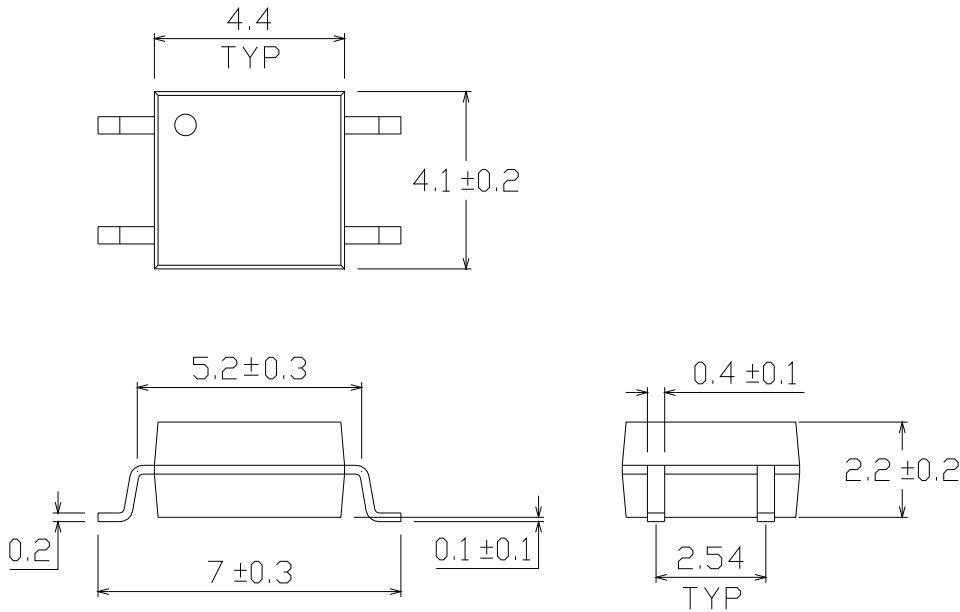

Recommended pad layout for surface mount leadform

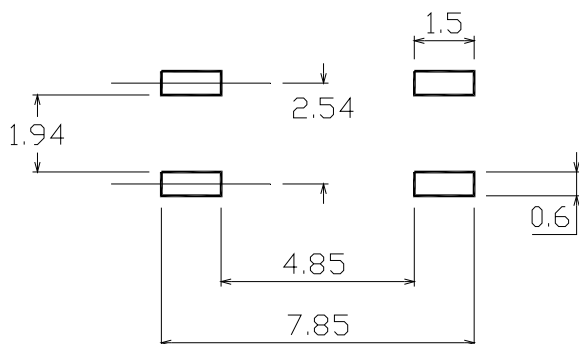



LIGHTING FOREVER

4 PIN SOP PHOTOTRANSISTOR PHOTOCOUPLER

EL357 Series

Device Marking



Notes

EL	denotes Everlight
357	denotes Part Number
R	denotes CTR Rank (A, B, C, D or none)
Y	denotes 1 digit Year code
WW	denotes 2 digit Week code
V	denotes VDE (optional)

4 PIN SOP PHOTOTRANSISTOR PHOTOCOUPLER

EL357 Series

Tape & Reel Packing Specifications

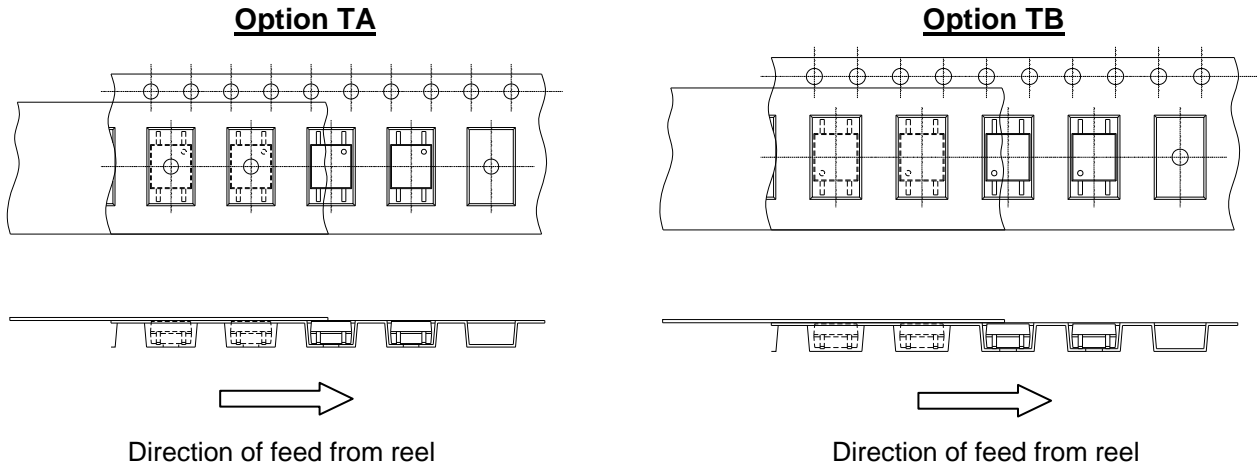

Tape dimensions

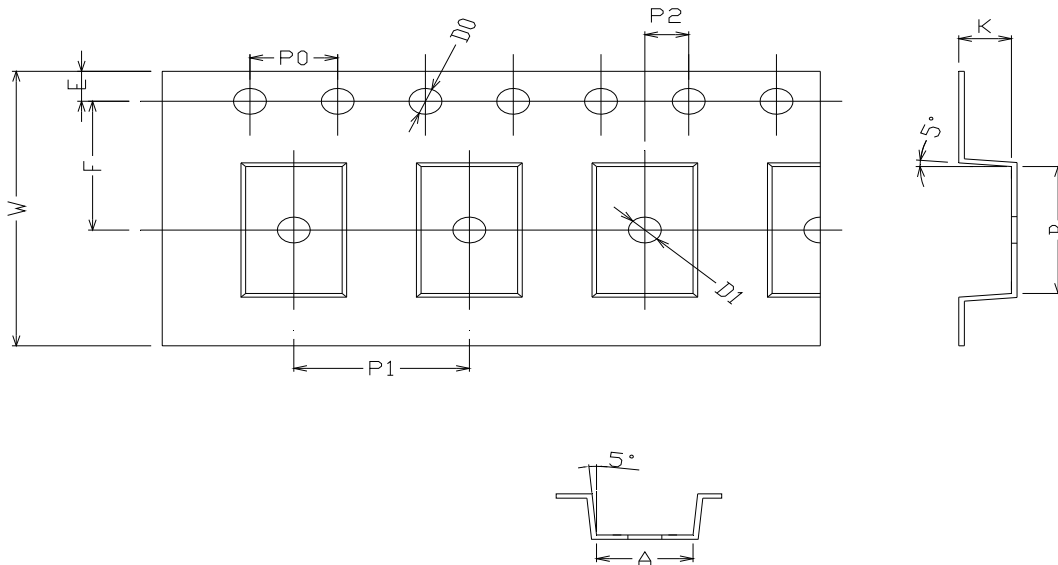

Dimension No.	A	B	Do	D1	E	F
Dimension (mm)	4.4 ± 0.1	7.4 ± 0.1	1.5 + 0.1/-0	1.5 ± 0.1	1.7 5± 0.1	7.5 ± 0.1
Dimension No.	Po	P1	P2	t	W	K
Dimension (mm)	4.0 ± 0.15	8.0 ± 0.1	2.0 ± 0.1	0.25 ± 0.03	16.0 ± 0.2	2.4 ± 0.1

4 PIN SOP PHOTOTRANSISTOR PHOTOCOUPLER

EL357 Series

Solder Reflow Temperature Profile

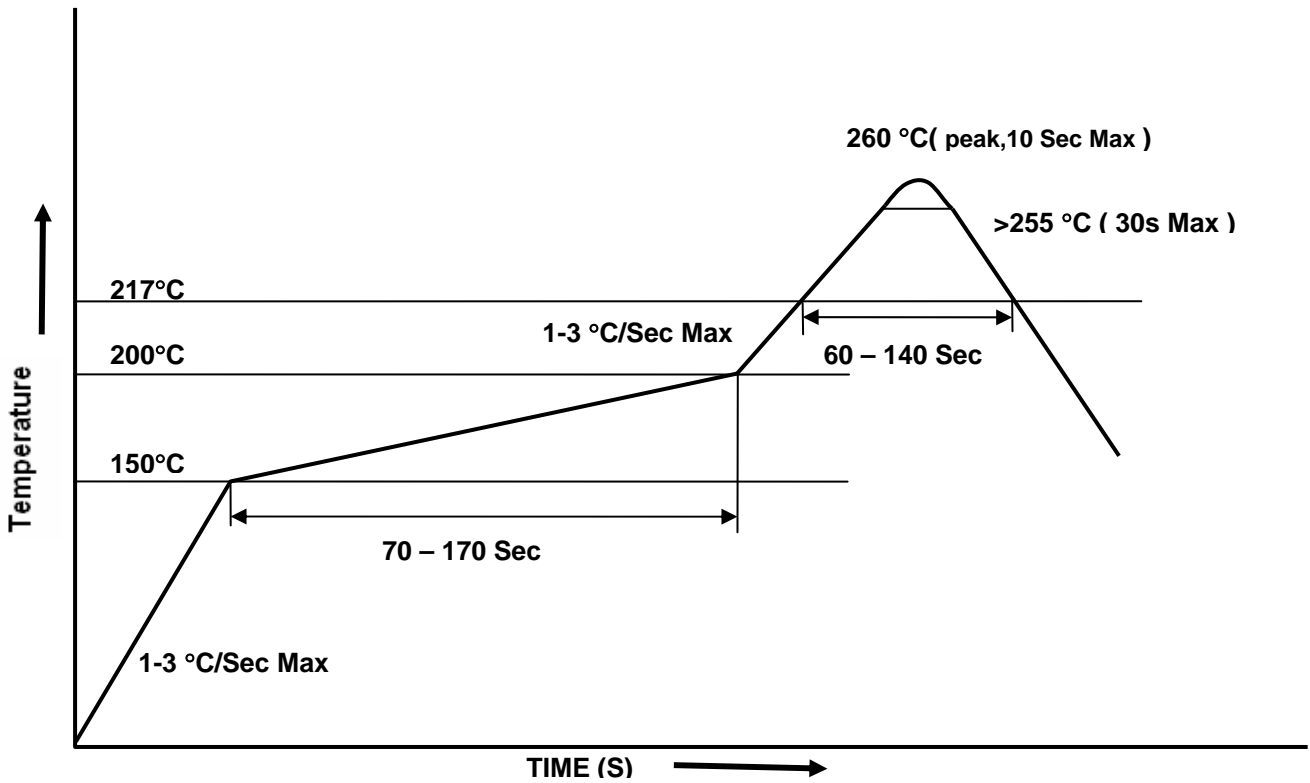



LIGHTING FOREVER

4 PIN SOP PHOTOTRANSISTOR PHOTOCOUPLER

EL357 Series

DISCLAIMER

1. The specifications in this datasheet may be changed without notice. EVERLIGHT reserves the authority on material change for above specification.
2. When using this product, please observe the absolute maximum ratings and the instructions for use as outlined in this datasheet. EVERLIGHT assumes no responsibility for any damage resulting from use of the product which does not comply with the absolute maximum ratings and the instructions included in this datasheet.
3. These specification sheets include materials protected under copyright of EVERLIGHT. Reproduction in any form is prohibited without the specific consent of EVERLIGHT.